

■全体図 (単位 mm) ($\frac{1}{100}$)

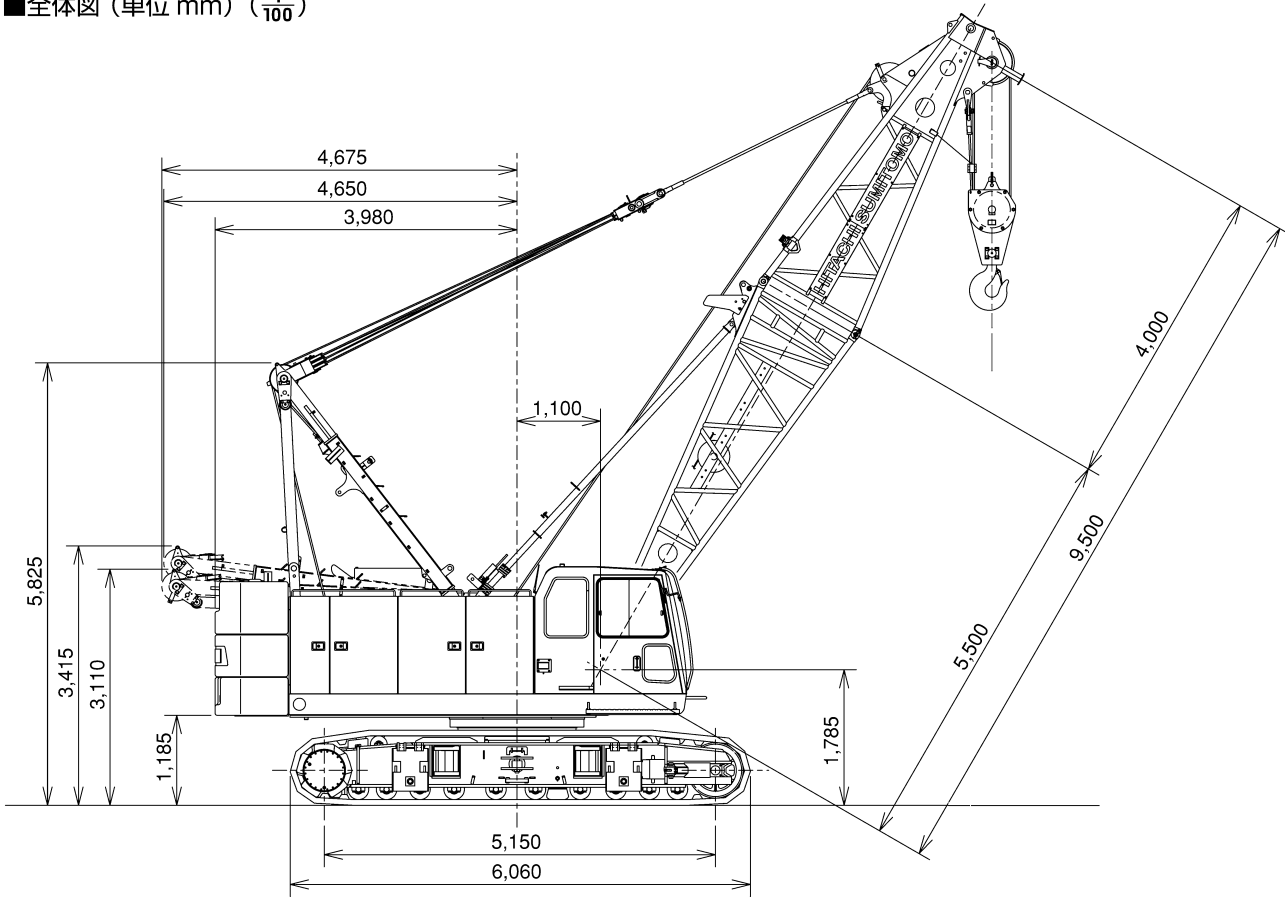

■作業範囲図

